

ROTEX SMART POSITIONER



THE SMARTEST POSITIONER:
ROTEX POSIDAPT™ SERIES

 **ROTEX**

Engineering For The Future

FEATURES

LCD DISPLAY

- Large LCD display for readability.
- No abbreviation or short form used.
- User friendly interface.
- On-screen display of diagnostics, alarms and error messages.
- Structured menu for parameters, setups and diagnostics.

SUPERIOR FUNCTIONALITY

- Contactless feedback, with patented algorithm.
- Blind Mount™, eliminates the need to orient mounting angle.

MODULAR DESIGN WITH ENCAPSULATED ELECTRONICS

- Fewer modules makes it easy to install, operate and maintain.
- Fewer number of internal components and moving parts, increased reliability and life span.
- Pre-fitted gauges, enclosed in IP66 enclosure ensure lifetime guarantee and reliability.
- Encapsulated electronics provide protection against moisture and humidity, avoiding failure of electronics.

PRECISE/RVO™

- Has built - in feedback sensor.
- Can accommodate wide variety of actuator volumes without need of flow control valve or volume booster.
- Metal-to-metal contact, low friction and high sensitivity.



WHY ROTEX SMART POSITIONER



Does your positioner fail, due to –

- Electronics failure due to humidity
- Due to wear and tear in potentiometer feedback



Does your valve hunt within positioner dead-band?



Do you face complexities in mounting and calibration?



Do you need handheld terminal or software to setup parameters?

ROTEX POSIDAPT™ positioners solve all of the above problems and guarantee performance!!



Simple easy **mounting**, Rotex mounting is so simple!

Simple easy **mounting**, Rotex mounting is so simple!
Interchangeability. Rotex mounts on
BOTH rotary and linear actuators.

Interchangeability: Rotex mounts on
BOTH rotary and linear actuators.

Calibration: Rotex positioner is the
simplest positioner to calibrate.

Calibration: Rotex positioner is the
simplest positioner to calibrate.

Performance: With Rotex unique **Adaptive PID Control**
learns your process, so it continuously improves its performance.

Repairability: Rotex has 3 parts, Housing,
PC Board, Servo. Each is quickly and easily replaceable as a spare part.

Want to add a
Position Feedback or Digital I/O to your existing
ROTEX Positioner?
Just add a **Position Transmitter or Digital I/O Module!!!**

There are many good positioners in the market, but
Rotex has developed the **"Smartest"** positioner,
with it's **Adaptive PID Control.**
So simple to mount and calibrate,
with fewer parts!



**What
makes
Rotex
Posidapt™ special?**

ROTEX SMART POSITIONER

SERIES

POSIDAPT^{ipst}

Partial Stroke Test, Emergency Shutdown Test, Online Test and Offline Tests, Advance Extended Diagnostics, and Parameters, HART / Foundation Fieldbus

POSIDAPT^{ultra}

Advance Parameters and Extended Diagnostics, Alerts, Online and Offline Tests, HART / Foundation Fieldbus

POSIDAPT^{super}

Advance Parameters and Extended Diagnostics, Alerts, Offline Test, HART / Foundation Fieldbus,

POSIDAPT^{expert}

Advance Parameters with Auto-tuning and Diagnostics, Hart / Foundation Fieldbus (optional)

POSIDAPT^{modern}

Basic Parameters with Auto-tuning and Limited Diagnostics

| Model | Basic Parameters | Servo Health Test | Advance Parameters | HART / FF Compatible | Alerts & Diagnostics | Advanced Diagnostics | Offline Test | Online Diagnostics | Partial Stroke Test | Solenoid Valve Test | Emergency Trip Test |
|--------|------------------|-------------------|--------------------|----------------------|----------------------|----------------------|--------------|--------------------|---------------------|---------------------|---------------------|
| Modern | ✓ | ✓ | - | - | - | - | - | - | - | - | - |
| Expert | ✓ | ✓ | ✓ | ✓* | - | - | - | - | - | - | - |
| Super | ✓ | ✓ | ✓ | ✓ | ✓ | ✓ | ✓ | - | - | - | - |
| Ultra | ✓ | ✓ | ✓ | ✓ | ✓ | ✓ | ✓ | ✓ | - | - | - |
| IPST | ✓ | ✓ | ✓ | ✓ | ✓ | ✓ | - | ✓ | ✓ | ✓ | ✓ |

*HART / FF is optional, to be selected while ordering

BLOCK DIAGRAM

ARCHITECTURE OF ROTEX SMART POSITIONER

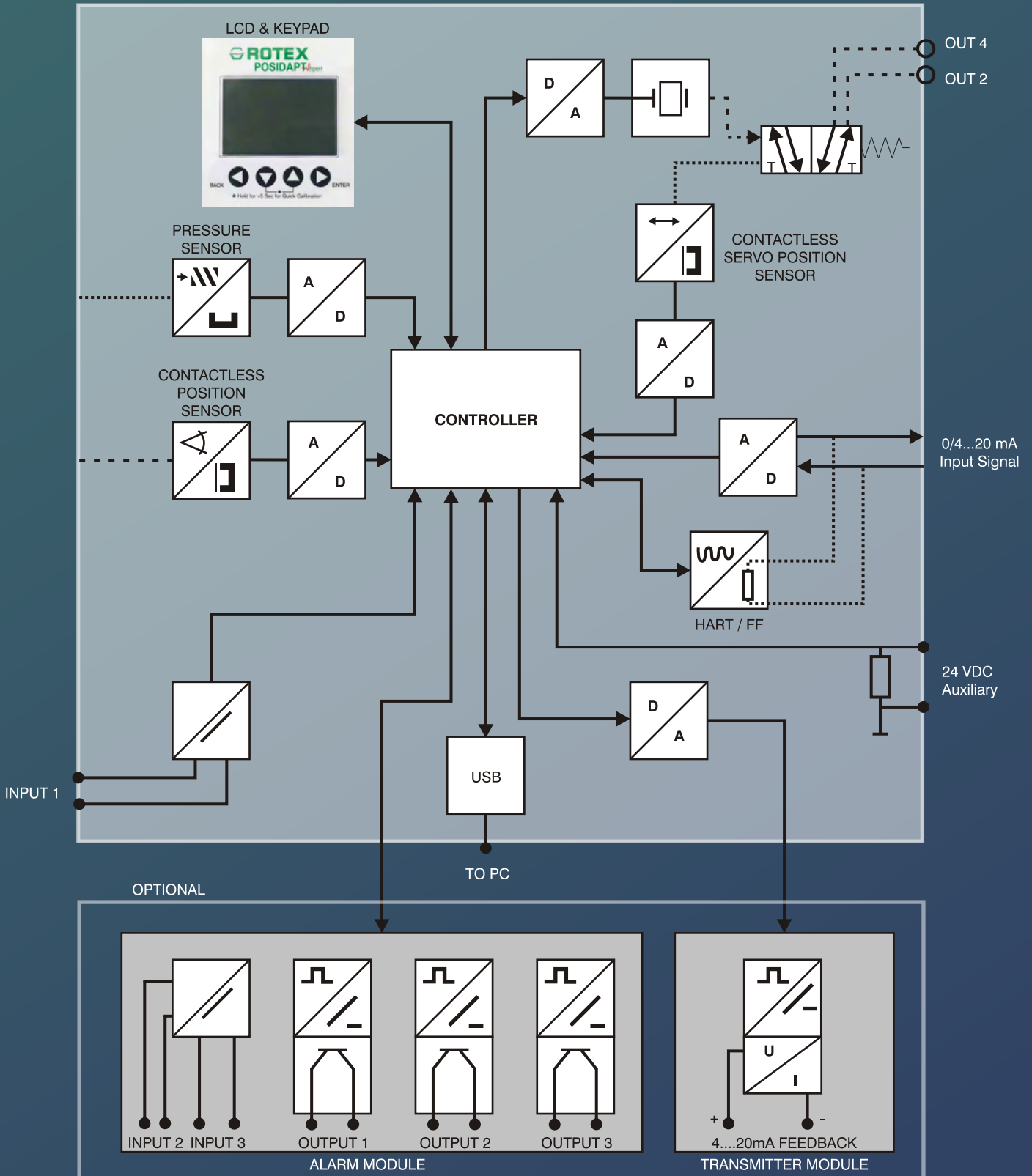

LCD DISPLAY

Push button on device

- Four push buttons enable ease of navigation
- Push button support following function
 - Configuration
 - Calibration
 - Allows termination of tests
 - Manual operation

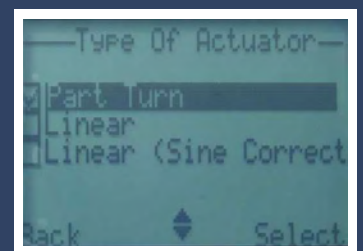
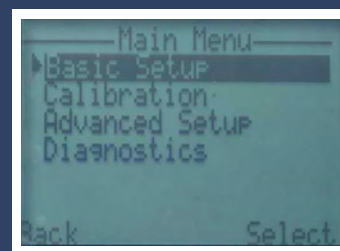
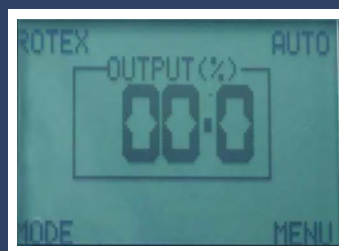
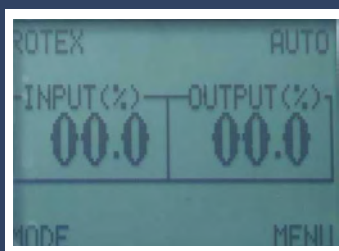

- Large LCD display for better readability.
- No abbreviation or short form used.
- Operator doesn't need to refer to the instruction manual for setting or calibration.
- User friendly interface.
- On-screen display of diagnostics, alarms and error messages.
- Structured menu for parameters, setups and diagnostics.
- Internal gauges enclosed for safety and protection.

“ Pre-fitted gauges are enclosed in an IP66 enclosure, which ensures that they are not damaged during transit or commissioning, providing higher reliability ”

CONTACTLESS FEEDBACK

“ Can start anywhere and end anywhere ”

NO DEAD ZONE!
NO “QUADRANTS” to align!



Configurable Shaft : No Dead Area

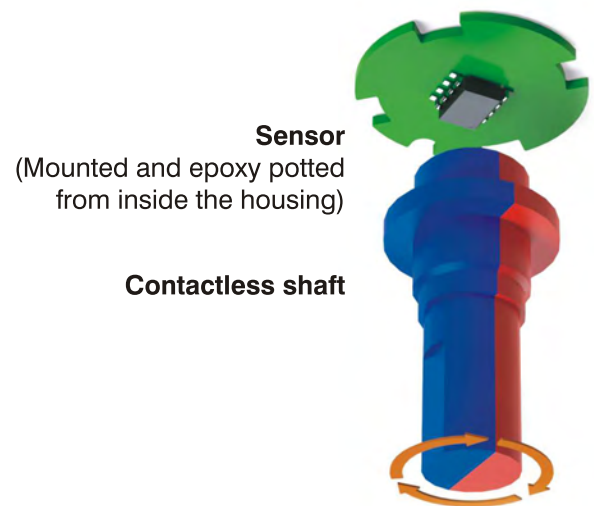

- 360° position sensing with freely rotating non-contact feedback shaft.
- No dead angle. Can start anywhere and end anywhere.
- Simple installation. Can be mounted on any type of actuator.
- Can control valve travel up to 359 degrees.
- Contactless, high resolution feedback.
- Blind-Mount, no need to orient mounting angle or direction.
- De-linked mounting option for high vibration / cyclic application.
- Same device for rotary and linear application, double acting or single acting.
- Extensive selection of mounting kits for various kind of actuators.

PRECISERVO™

“ Suitable for versatile applications, meeting your most basic to advanced needs!! ”

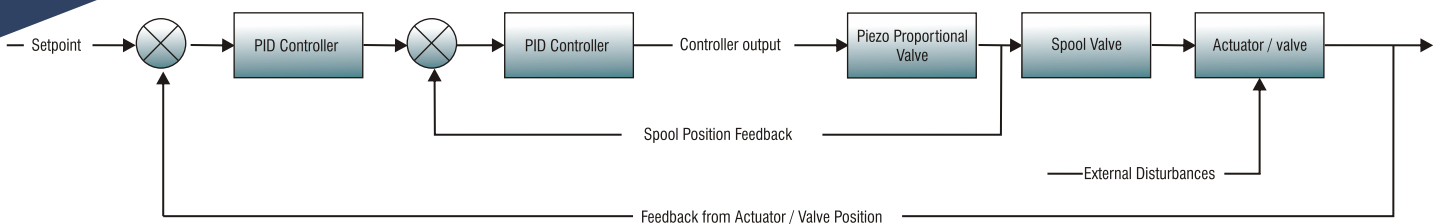

Preciservo™ operates with adaptive dual PID loop and ensures high accuracy, lower dead band and extremely steady performance of positioner. Primary loop is controlling the spool position of Preciservo™ and secondary loop is controlling the actual position.

Dual PID loops eliminate overshoot, undershoot, hysteresis and “hunting”. ROTEX POSIDAPT can maintain steady state and set point with the highest degree of confidence.

- Preciservo™ has metal to metal contact ensuring low friction and high sensitivity.
- Precise manufacturing assures negligible hysteresis and dead band.
- Rotex Preciservo™ feedback enables fine control of orifice resulting in wide flow capacity.
- Rotex Preciservo™ valve can vary the orifice due to primary PID loop. Hence different sizes of actuators can be calibrated without the need of flow control valve or volume booster.
- Diminutive steady state bleed rate:
< 1 lpm/ 0.037 SCFM @ 4 bar.
- Rotex Preciservo built in self-health check, ensures best performance and reliability during calibration and test.

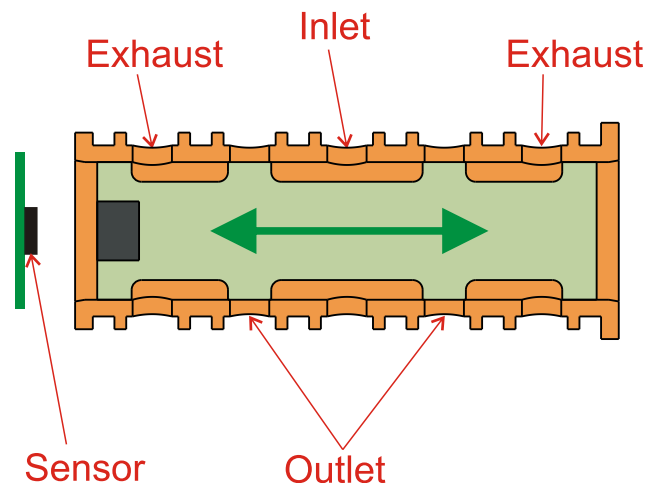

ENCAPSULATED ENCLOSURE

“ Rotex encapsulates all electronic modules to prevent corrosion and electronic failures! ”

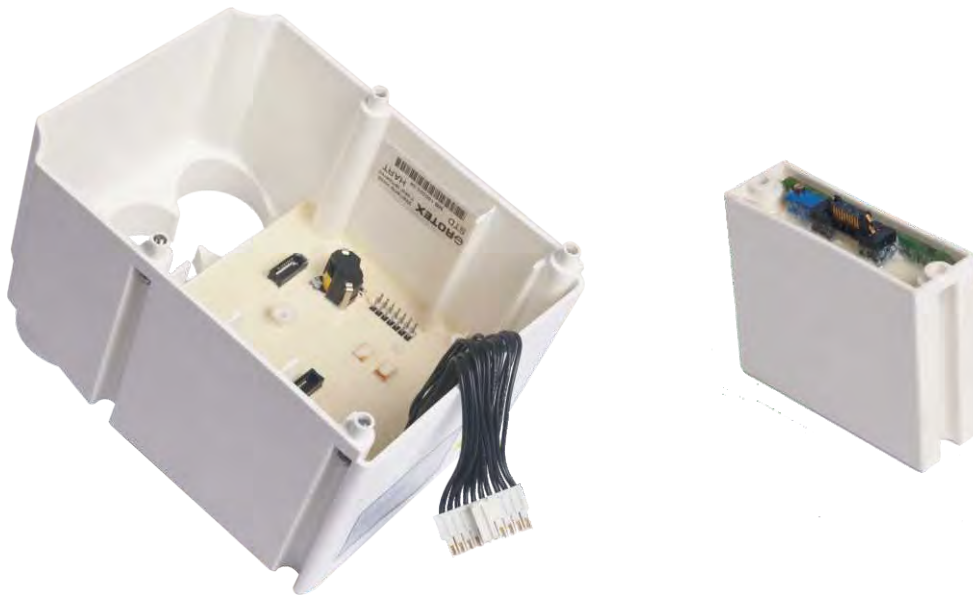

Major failures are seen in electronics mainly due to moist instrument air or external humidity, damaging the exposed electronic parts.

- Housing is designed from engineered resin Makralon[®], that can withstand harsh, corrosive and moisture laden environments. This gives complete protection of electronics and gauges.
- Actuator exhaust is not released inside the housing. The exhaust is connected to the port on the body. Port is threaded to allow piping to external locations which keeps the surrounding clean and contamination free.
- Ideal for pharmaceutical and clean room application.
- Applications like using Natural Gas in the positioner are only possible with such an arrangement. Rotex offers this unique feature.



REMOTE MOUNTING



- Remote mount with non-contact feedback.
- Remote mount distance up to 45 m.
- IP67 remote mount unit.
- Ideal for extreme environments and harsh conditions - high temperature, vibration, frequency or difficult to reach locations.
- ROTEX shielded cable and circular connectors ensure better connectivity and integrity.
- No additional power supply required for the sensor.

FEATURES



SIMPLE to install

- uses standard mounting kits!

SIMPLE to calibrate

- 2 fingers, 5 minutes: DONE!

SIMPLE to maintain inventory

- one model for any actuator!

- Compact, modular and innovative design.
- Fewer number of internal components and moving parts, increased reliability and life span.
- Protection rating up to IP66.
- Intrinsically safe option available.
- Full aluminium and stainless steel enclosure available.
- Remote mounting possibility.
- Rugged design.
- Vast temperature operating range.
- Vibration and impact tolerant.
- Low energy and air consumption.
- Higher control ability and reliability.
- Excellent dynamic stability.
- Fast response to control signal change with maximum sensitivity.
- Highly reliable internal feedback accuracy.
- Cascaded control loop for high accuracy and repeatability.
- Simple installation. Can be mounted on any type of actuator.
- Same device for rotary and linear actuators, double acting or single acting actuators.
- Quick / direct calibration option with extensive selection of mounting kits for most actuators.

CONFIGURATION CAN BE DONE VIA

- Push button
- Asset Management tool
- Handheld
- DCS
- EDDL
- Dedicated application for non-Hart and Hart device through USB



MOUNTING

- Mounting as per Namur, VDI/VDE 3845 and DIN/IEC 534
- Universal Device - Ideal for linear or rotary application

POSITIONER TRANSMITTER MODULE

- The loop-powered position transmitter: 4 – 20 mA
- Potentially separated from standard controller
- Output range can be configured, irrespective of the direction of action

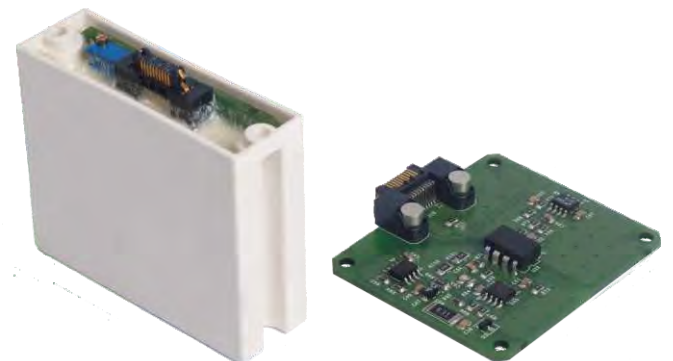

ALARM MODULE (DIGITAL I/O)

- Two configurable solid state switches (digital input, only one on alarm module)
- Can trigger safety function based on configuration
- Function is based on the change in the signal status
- Three digital outputs, can trigger signal based on different function threshold

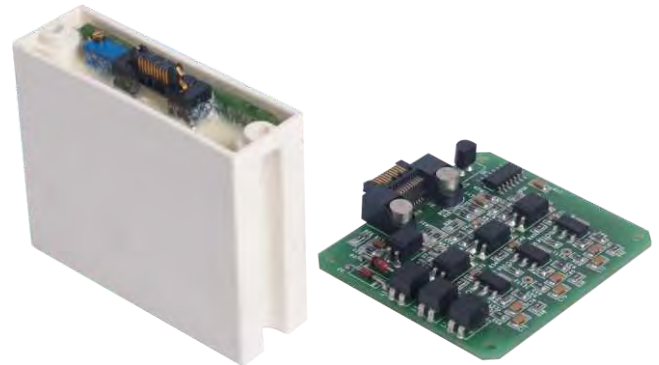

PRECISE/RVO MODULE

- Module 1: Double Acting or Spring Return for fail safe or fail close (same servo)
- Module 2: Single Acting Reverse with Solenoid Valve Testing (Normally Open)
- Module 3: Single Acting Direct with Solenoid Valve Testing (Normally Close)
- Module 4: Stay-Put / Fail Freeze

COMMUNICATION

- Compatible with Foundation Fieldbus, Profibus PA and HART version 5 and 7
- DTM framework version 1.2.1
- DTM and EDD based on multi-system support configuration



PARTIAL STROKE TEST

Partial Stroke Test (PST) is a method to check, detect and ensure availability of safety function on demand. PST physically moves the valve to a predefined position, without affecting or disturbing the current process requirement.

Partial stroke test can prevent unexpected failure of safety function and provides information on current health status of valve, actuator and positioner.

Rotex Posidapt smart positioner performs self-health test prior to initialisation of partial stroke test, ensuring additional safety and process availability on demand.

Partial stroke test can be initiated through -

- Handheld device
- Remote push button or binary input
- DTM / EDD using asset management system
- Pre-defined configured time interval

ROTEX POSIDAPT Smart Positioner has safety or demand as priority. Any other demands override the test.

Test will be aborted and returned to normal operation in case of:

- Partial stroke fails
- Push button is held >5 seconds
- Safety DEMAND occurs

Partial stroke test results can be saved and compared over the course of time.

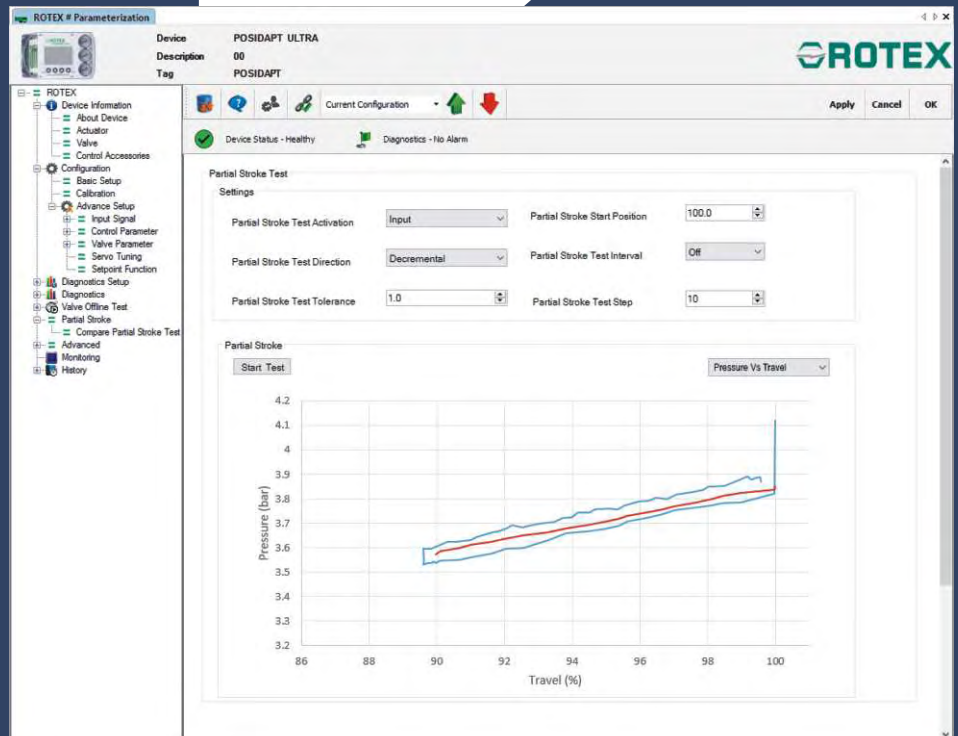

DIAGNOSTICS

- Logical trend and histogram.
- Diagnostics with errors and recommendations.
- Alarm based on different threshold.
- On screen notification up to last 3 alarms or errors.
- Recorded data history for 25 years based on averaging method.
- Offline test.
- Online monitoring.

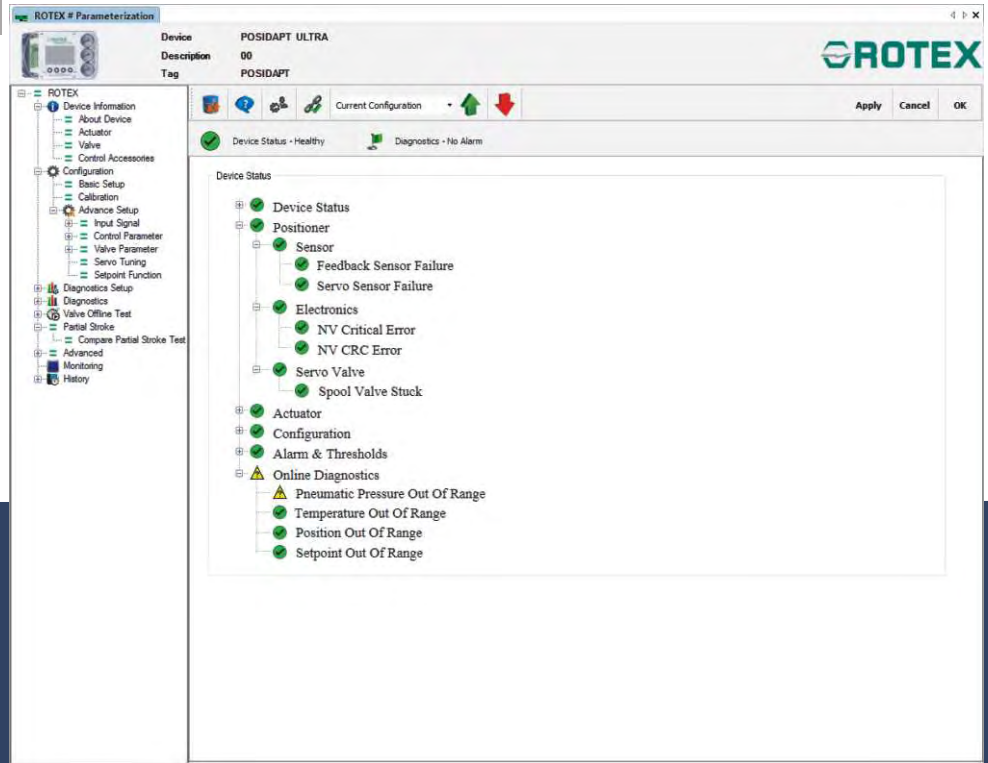

DIAGNOSTICS CAN IDENTIFY THE FOLLOWING ISSUES -

Valve Faults

- Valve clogging
- Valve seat or valve build-ups
- Seat erosion
- Increase in friction
- Leakage through bushing, covers, connections
- Valve tightness

Positioner Failure

- Electronics failure
- Servo valve fault
- Pressure sensor failure
- Feedback sensor failure

Actuator Faults

- Friction
- Spring failure
- Leakage through bushing, diaphragm seals, covers, connections

External Faults

- Unexpected change in supply pressure, (sudden drop or increase)
- Change in rate of flow or change in ΔP across the valve

- Monitoring parameters can be configured with three different threshold levels.
- Each threshold level can be classified based on severity and generates a digital feedback signal, once triggered.
- Colour code represents nature of severity. (can be communicated on HART to control system) This enables users to take necessary preventive action.



No Events



Primary - Maintenance Required



Secondary - Maintenance Demanded



Tertiary - Immediate maintenance or repair needed

OFFLINE TEST AND ONLINE DIAGNOSTICS

STEP RESPONSE TEST

Step response test provides information about the friction of the valve and actuator. It provides dead time (time required for the valve to respond to the given change of setpoint), response time for it to reach 63% and 86 % of the specified step change. It also detects overshoots, if any. The result can be compared over the course of time for detailed analysis.

DYNAMIC LOOP TEST

Dynamic loop test provides information on dynamic dead band of the valve assembly. The valve will open or close with change in the input setpoint.

VALVE CHARACTERISTIC TEST

Valve characteristic test is a method which identifies various parameters and operating conditions of the valve assembly. It analyses the static and dynamic condition of the valve. During the test, it records data at various positions. This data can be compared over the course of time to analyse maintenance or repair requirements.

DEAD BAND TEST

Dead band test identifies how accurately the valve can achieve the desired setpoint. This test can give a fair conclusion on stiction and sensitivity of the assembly.

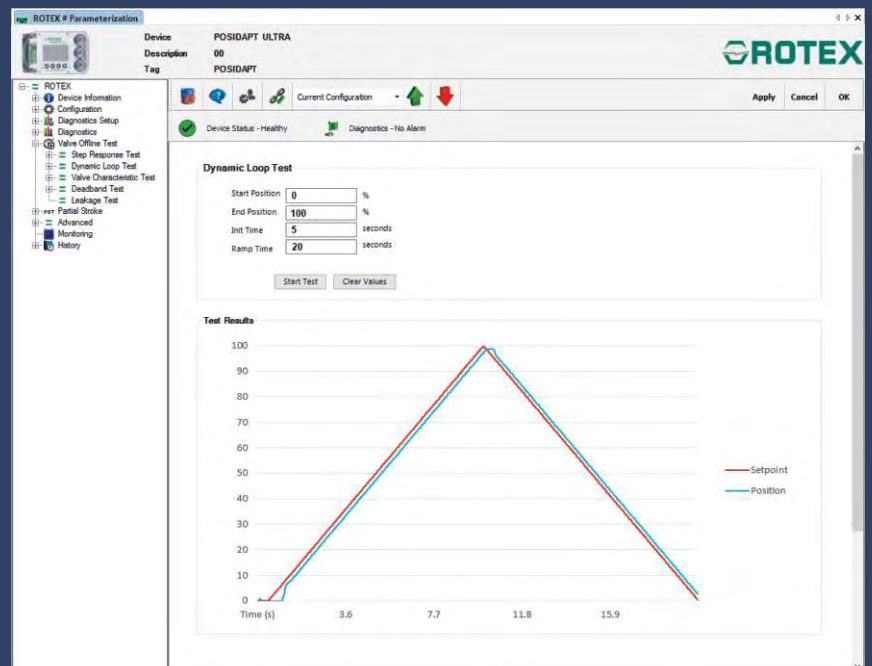
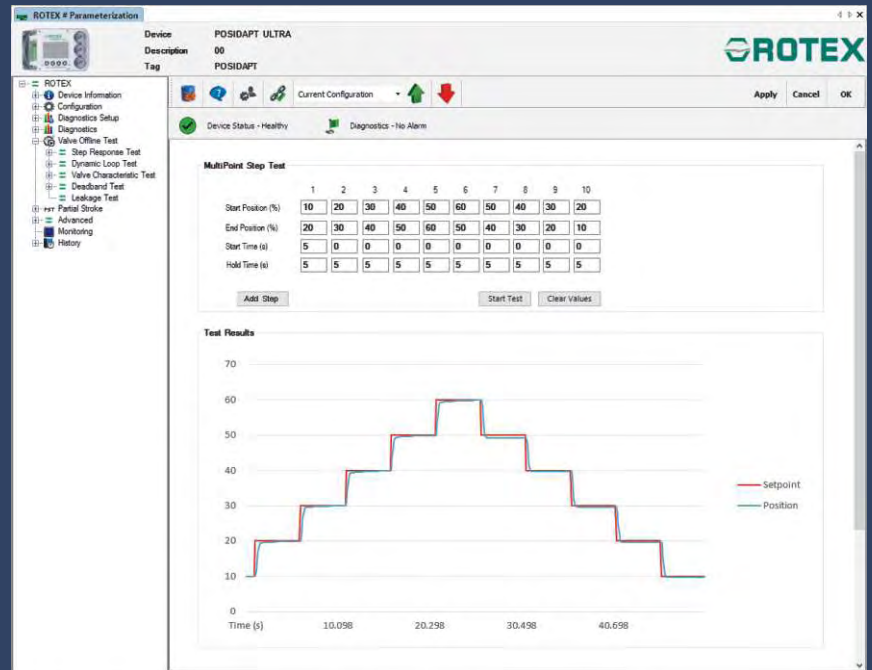

DIMENSION DETAILS

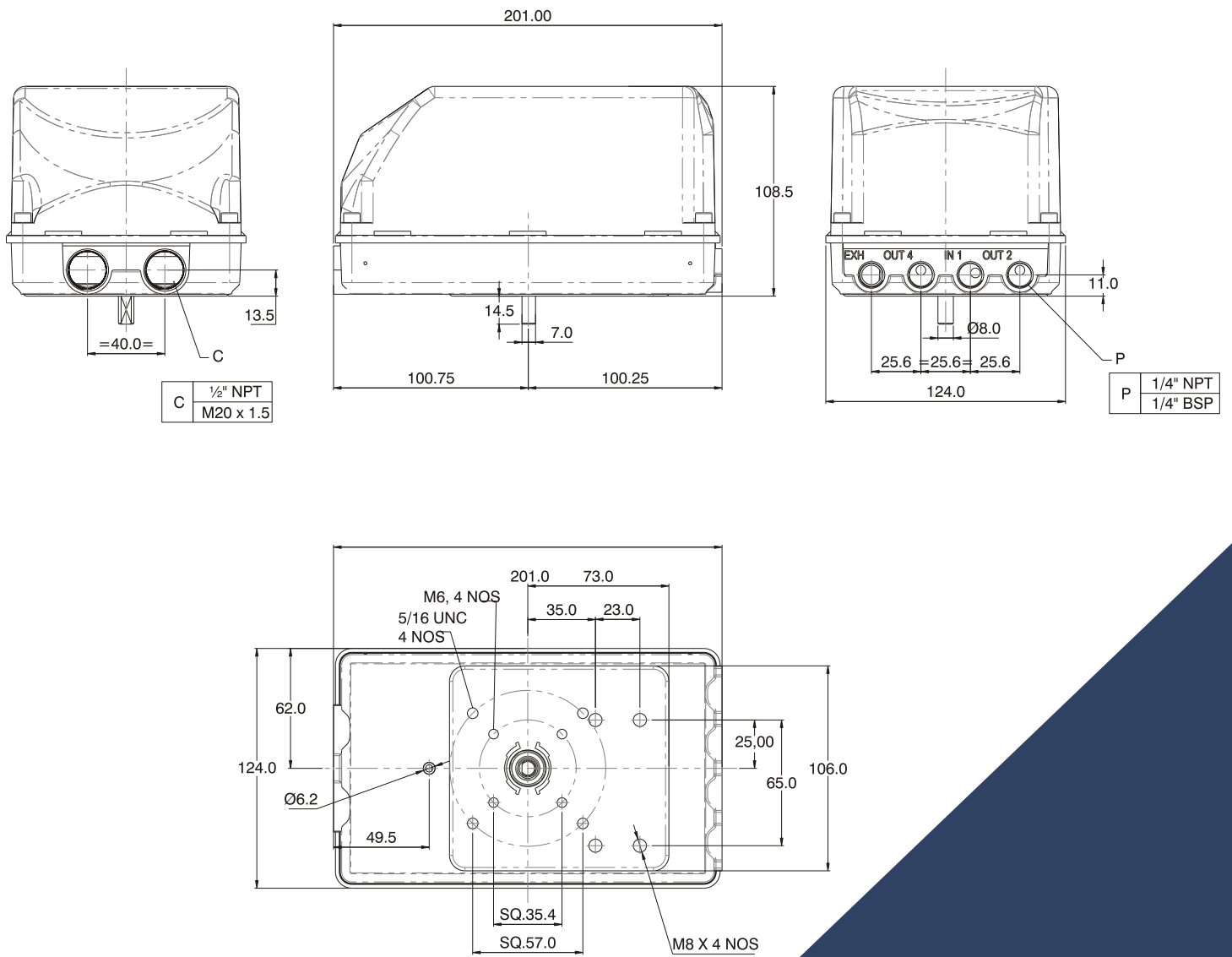

APPLICATIONS

POWER CYLINDER



- 100 % adjustable position for each mA.
- Rotex positioner ensures hunting far less than dead band. Effective dual PID with adaptive controls makes this possible.
- Negligible deadband and hysteresis.
- Standard temperature range is -20 °C to 85 °C (-4 °F to 185 °F). Low temperature version is available.
- Extremely rugged for harsh and dusty environment.
- Completely epoxy potted electronics to protect against moisture and physical abuse.
- Fail Freeze option is available for DA applications. Fail in place, on air or power failure.

- Rotex Smart positioners can calibrate on very small actuators without the use of external flow control valves.
- Can accommodate a stroke up to 359° of rotation.
- Quick and playless kits available as an option.
- Can be set open or close or stay put from menu.
- Valve position feedback and percentage display can be reversed.
- Different alarms for different conditions are possible.

ROTARY ACTUATOR



APPLICATIONS

CONTROL VALVE

- Easy set up, can be used as 33° or 90°, it self learns.
- Negligible Hysteresis and dead band.
- Parametric setting of Full Close or Open at end signals.
- One positioner can control SA or DA actuators.
- Compensated operation from linear to rotary conversion.
- Fixed pin on stem or fixed pin on lever.
- Freely configurable operation based on valve characteristics.
- Menu defined gains for square and square root characteristics.
- Menu driven ramp control using velocity function.
- Remote mount up to 10 m distance.



TECHNICAL SPECIFICATION

● Rotex Unique Feature

| | |
|---|--|
| Instrument Air | |
| Air Quality | In accordance to ISO 8573-1 |
| Solid Particles | Class 5 (maximum density 3 mg/m ³ , 5 μm filtration is recommended) |
| Humidity | Class 1 (dew point 10° C below minimum operating temperature) |
| Oil | Class 3 (Maximum concentration 5 mg/m ³ or < 1 ppm) |
| Electronics & Electrical | |
| Supply Power | 4 to 20 mA (2 wire system) 18 to 30 VDC (4 wire system) |
| Signal | 4 to 20 mA, 0 to 20 mA (only with 4 wire system), both with or without HART signal |
| Minimum Signal | ≥ 3.6 mA |
| Current Max | 36 mA (with overload protection) |
| Load Voltage | 9.7 VDC @ 20mA (max 30 VDC) |
| Impedance | 485 Ω at 20 mA |
| Wire Cross Section | Screw terminals max. 2.5 mm ² (AWG 14) |
| Characteristic & Performance | |
| Characteristics | Linear, 1:25, 1:33, 1:50, 25:1, 33:1, 50:1, and freely configurable |
| Deadband | Configurable from 0.1% to 10% |
| Hysteresis | ≤ 0.5 % |
| Deviation | ≤ 0.5 % |
| Position Transmitter Module | |
| Output | 4 to 20 mA (2 wire system) |
| Supply Voltage | 12 to 30 VDC |
| Total Operating Range | 3.6 to 21 mA |
| Transmission Error | ≤ 0.3 % |
| Influence of Temperature | 0.35% / 10° K |
| Alarm Module | |
| Supply Voltage | 12 to 30 VDC |
| Max Supply Voltage | ≤ 35 VDC |
| Signal Current | ≥ 2.1 mA (Logically HIGH) ≤ 1.2 mA (Logically LOW) |
| Total Digital Output | 3 |
| Total Digital Input | 2 [^] |
| Voltage | 30 VDC |
| Communication | |
| | HART 5 & 7 |
| | Foundation Fieldbus** |
| | Profibus PA** |
| Certification | |
| Atex | II 2 GD Ex ia IIC T6 Gb*** II 2 GD Ex d IIC T6 Gb*** |
| Safety | Upto SIL3*** |

* Special corrosion resistance design available on request

** On request

*** Certification pending

^ 1 Digital input on board

ROTEX SMART POSITIONER

ORDERING CODE

| A | | B | | C | |
|---------------|-----|--|---|---|----|
| Series | | Model | | Enclosure | |
| Posidapt | RTX | IPST - Partial Stroking Device | 5 | Polycarbonate (Makrolon®) Cover, Aluminium Body | 1* |
| | | Modern ^ - Limited Diagnostics | 6 | Aluminium Cover, Aluminium Body | 2 |
| | | Expert - Basic Diagnostics | 7 | Ex d - Aluminium Cover, Aluminium Body | 3 |
| | | Super - Offline Tests and Diagnostics | 8 | Ex d - Stainless Steel Cover, Stainless Steel Body | 4 |
| | | Ultra - Online, Offline Tests and Extended Diagnostics | 9 | Ex ia - Polycarbonate (Makrolon®) Cover, Aluminium Body | 5 |
| | | | | Ex ia - Aluminium Cover, Aluminium Body | 6 |
| | | | | Ex ia - Stainless Steel Cover, Stainless Steel Body | 7 |
| | | | | Stainless Steel Cover, Stainless Steel Body | 8 |

| D | | E | | F | |
|-------------------------------|----|----------------------------------|----|----------------------|---|
| Servo | | Pneumatic Port Connection | | Communication | |
| Double Acting / Single Acting | 1* | 1/4" BSP | 2G | None | * |
| Single Acting (Port 4)** | 2 | 1/4" NPT | 2R | Hart | H |
| Single Acting (Port 2)** | 3 | | | Foundation Fieldbus | F |
| Fail Freeze | 4 | | | Profibus PA | D |

| G | | H | | I | |
|---|---|--------------------|----|-------------------------------------|----|
| Module | | Cable Entry | | Temperature | |
| None | * | 1/2"NPT (F) | 4R | -20 °C to +85 °C (-4 °F to 185 °F) | * |
| Position Transmitter (4 to 20 mA) | P | M20X1.5 (F) | 3M | -40 °C to +85 °C (-40 °F to 185 °F) | FS |
| Alarm (Digital I/O) | A | | | -55 °C to +85 °C (-67 °F to 185 °F) | LT |
| Position Transmitter (4 to 20 mA) + Alarm (Digital I/O) | B | | | | |

| J | | K | |
|----------------------|---|-----------------------|------|
| Certification | | Remote Mount # | |
| None | * | None | * |
| ATEX | A | 3 metres | RM03 |
| SIL | S | 5 metres | RM05 |
| CCOE | C | 7 metres | RM07 |
| IECEX | I | 10 metres | RM10 |
| FM | F | 20 metres | RM20 |
| | | 30 metres | RM30 |
| | | 45 metres | RM45 |

Notes:

- * Default; no character included in model number.
- ** Servo with external solenoid valve testing and available with IPST model only.
- # It is mandatory to use Rotex connectors and cables for remote mount version.
- ^ Cannot be supplied with HART version.

Example:

RTX-7-1-1-2G-P-4R
 Posidapt Expert with Polycarbonate enclosure (Makrolon®), double acting servo valve, pneumatic port connection of 1/4" BSP, built in position transmitter (4 to 20 mA), cable entry 1/2" NPT.

ACCESSORIES ORDERING CODE

| | |
|--|-------|
| Coupler for rotary actuator ISO 5211 | RC001 |
| Linkage for stroke up to 100mm, pin on stem | PS100 |
| Linkage for stroke up to 200mm, pin on stem | PS200 |
| Linkage for stroke up to 100mm, pin on lever | PL100 |
| Linkage for stroke up to 200mm, pin on lever | PL200 |

ALUMINIUM HOUSING





Engineering For The Future

ROTEX GROUP SALES HEAD QUARTER
B/703/704, Western Edge-II, Off Western Express Highway,
Borivli (East), Mumbai-400066
Phone : +91 22 42111444
Fax : +91 22 42111400
Email : sales-bby@rotexautomation.com

ROTEX MANUFACTURERS AND ENGINEERS PRIVATE LIMITED
Plot No. R-852 / 853, TTC Industrial Area, Rabale, Navi Mumbai- 400701
Phone : +91 22-20871065 / 66 / 67 / 68
Email : rmepl@rotexautomation.com

ROTEX AUTOMATION EUROPE
Bierstraat 117
3011 XA Rotterdam
The Netherlands
Phone : +31-88-5053505
E-mail : europe@rotexautomation.com