

# THERMIGEN™

Shell & Tube Type Thermic Fluid Steam Generator

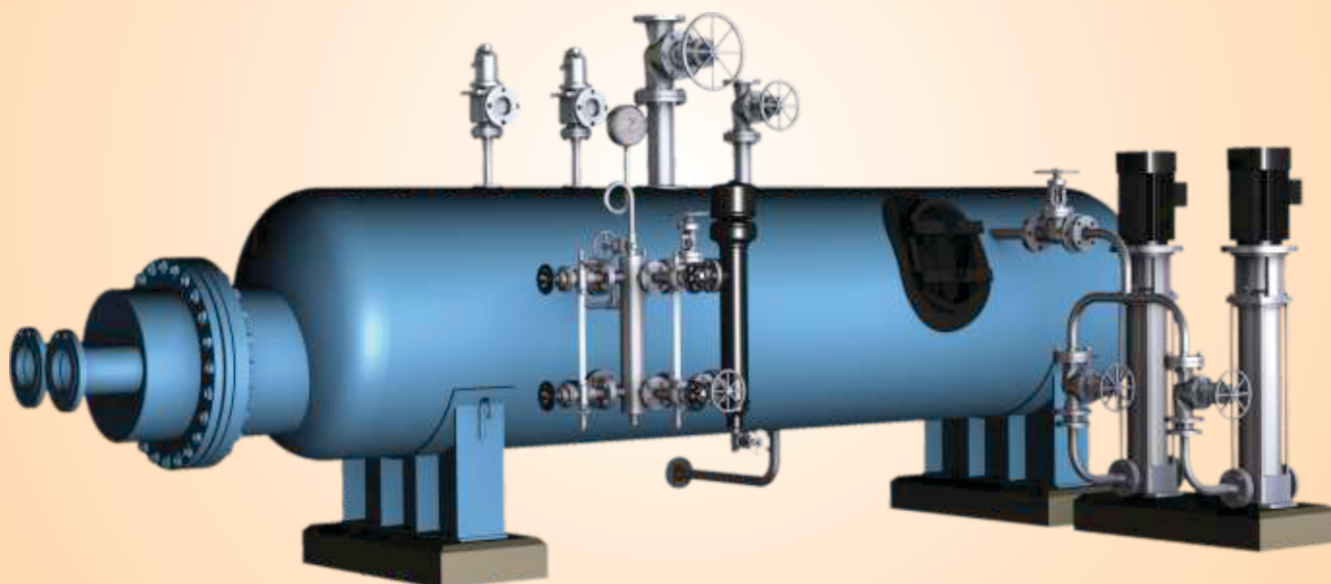

## Heating Business

### Improving your business is our business

Thermax is an engineering major providing sustainable solutions in the areas of energy and environment. Spanning over 86 countries, clients make use of Thermax's business-to-business solutions for heating, cooling, power and cogeneration plants; waste heat recovery units; systems for water & wastewater management and air pollution control; performance improving chemicals.

Thermax's operations are supported by ongoing Research & Development, tie-ups with global technology majors, an international sales & service network spread over 27 countries and state-of-the-art manufacturing facilities in 14 locations including India, Indonesia, China, Poland, Denmark and Germany.

As a part of Thermax, Heating business - a strategic business unit offers packaged boilers, thermal oil heaters, waste heat recovery boilers, hot water and air generators. These are available in modular construction as a standard package configuration or a custom design for specific requirements. Innovated by a strong R&D that focuses on customer applications, we offer a range of heating systems designed to combust wide range of solid, oil & gas fuels including biomass and heavy liquid fuels. Heating SBU helps small and medium firms & fortune 500 companies to reduce energy cost with a worldwide presence of oil & gas based systems in Middle East and Europe, biomass and solid fuel fired equipment in South East Asia and Africa.

Process Industry needs heat in different form & using different fluid for various processes. Typical requirements are Steam, hot air & Thermal oil. Thermax –A pioneer in Thermal Oil Heating Systems in India had introduced many conceptual products & Systems. Thermigen is one of such effective innovative solution producing Steam using heat from Thermal Oil.

Thermigen is a perfect solution where customer needs higher size of Thermal Oil heater & also has small / medium size of steam demand.

Thermigen is a shell & tube type, **IBR designed & manufactured**, thermic fluid steam generator. It works on heat exchange principle from hot Thermal oil running through tubes immersed in water bath inside the shell. The steam is also produced in shell.

## Benefits to the Customer

- No hassles of carrying-conveying fuel & related aspects like spreading-raking-poking etc.
- No hassles for ash removal, cleaning as well maintenance related to burner / combustor
- Thermal oil circuit have additional safeties such as pressure switch, pressure alarm, low flow cut off
- Required pressure & temperature gauges provided at inlet and outlet of thermic fluid line for necessary online readings.

## Unique Design Features

**Single fuel firing** - Thermigen offers the benefit of generating steam using thermic fluid as a heat source, so steam generation as well as thermal oil heating for the process are achieved using a single fuel. This eliminates the need to install a separate boiler to handle small process steam requirements.

**Flexible Integration** - Thermigen can be integrated with any thermal oil heater fired on oil, gas or solid fuels.

**Low Footprint** - Thermigen can be installed in a compact area, making it possible to be fit into existing layouts, which would not be possible with conventional boilers.

**Safe and Reliable Operation** - The unit comes with high safety interlocks designed to monitor and control critical parameters like thermic fluid flow, pressure and water level in the unit.

**Quality** - The Thermigen shell is made of Boiler Quality **SA 515/516 Gr.70** plate and sealed with **dish ends**. The unit is manufactured in accordance with Indian Boiler Regulations (IBR)

## Technical Specifications

Description	Unit	TSG 1000	TSG 1500	TSG 2000	TSG 3000
Capacity (F&A 100 °C)	kg / hr	1000	1500	2000	3000
Design Pressure	kg / cm <sup>2</sup> g	10.54			
Type	Shell & tube type heat exchanger				
Orientation	Horizontal				
Fluid	Shell side - Water & Steam / Tube side - Thermal Oil				
Thermic fluid Flow rate	m <sup>3</sup> / hr	29	43	58	87
Thermic fluid Inlet / Outlet temperature	°C	270 / 230			
Connected Electrical Load	kW	2.70	2.70	2.70	3.50
<b>Dimensions &amp; Weight</b>					
Length	mm	3215	3965	4980	4980
Width	mm	2575	2575	2575	2710
Height	mm	2150	2150	2150	2150
Dry weight	kg	2200	2875	3000	3200
Flooded Weight	kg	3775	5125	6000	6500

Note : Above mentioned weight and dimensions may vary with actuals. Please refer to offer document for more details. For higher capacity Thermigen, Contact HO. Customer need to install control valve on thermic fluid line coming out from Thermigen.



## General Arrangement

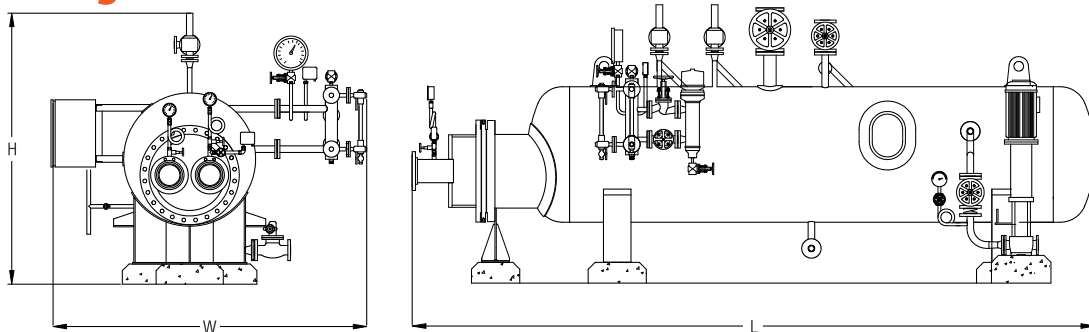

**THERMAX**

www.thermaxglobal.com





### Registered Office

D-13, MIDC Industrial Area, R D Aga Road, Chinchwad,  
Pune 411019, India Customer Care : 1800-209-0115

 @thermaxglobal

 @thermaxlimited

 enquiry@thermaxglobal.com

 @thermax\_global

 @thermaxglobal

 @thermaxmedia

### Thermax Business Portfolio

- Heating
- Cooling
- Power
- Air Pollution Control
- Chemicals
- Water and Wastewater Solutions
- Solar
- Specialised Services